

XBS306P11R-G

ETR16029-001

Schottky Barrier Diode, 3A, 60V Type

FEATURES

Low Forward voltage

Environmentally Friendly : EU RoHS Compliant

PRODUCT NAME

PRODUCT NAME	PACKAGE	ORDER UNIT
XBS306P11R-G *	SMA-PG	1,800/Reel

* The "-G" suffix denotes Halogen and Antimony free as well as being fully EU RoHS compliant.

* The high-melting solder paste (lead-containing) is used as attachment.

MARKING

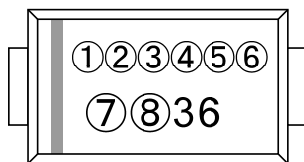

①②③④⑤⑥⑦⑧: Control Number



APPLICATIONS

- Rectification
- Protection against reverse connection of battery

PACKAGING INFORMATION

● SMA-PG

Unit : inch (mm)

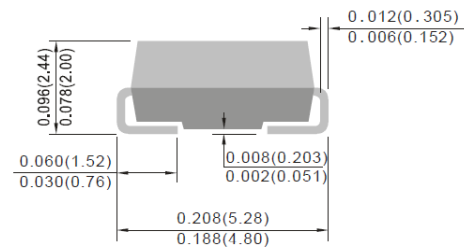
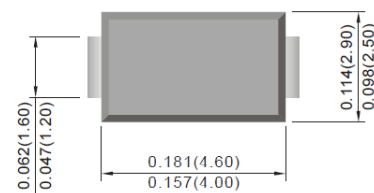

ABSOLUTE MAXIMUM RATINGS

Ta=25°C

PARAMETER	SYMBOL	RATINGS	UNITS
Repetitive Peak Reverse Voltage	V_{RM}	60	V
Reverse Voltage (DC)	V_R	60	V
Forward Current (Average) at Ta=75°C	$I_{F(AV)}$	3	A
Non Continuous Forward Surge Current (8.3 ms single half-sine wave)	I_{FSM}	80	A
Junction Temperature	T_j	150	°C
Storage Temperature	T_{stg}	-55 to +150	°C

ELECTRICAL CHARACTERISTICS

Ta=25°C

PARAMETER	SYMBOL	TEST CONDITIONS	LIMITS			UNITS
			MIN.	TYP.	MAX.	
Forward Voltage	V_F	$I_F=3A$	-	-	0.75	V
Reverse Current	I_R	$V_R=60V$			100	μA

TYPICAL PERFORMANCE CHARACTERISTICS

(1) Forward Current vs. Forward Voltage

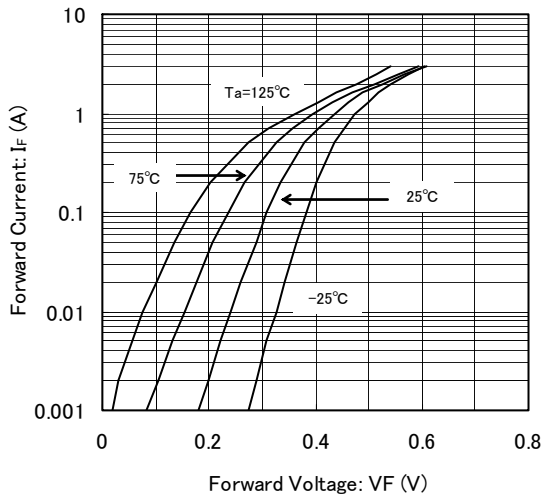

(2) Reverse Current vs. Reverse Voltage

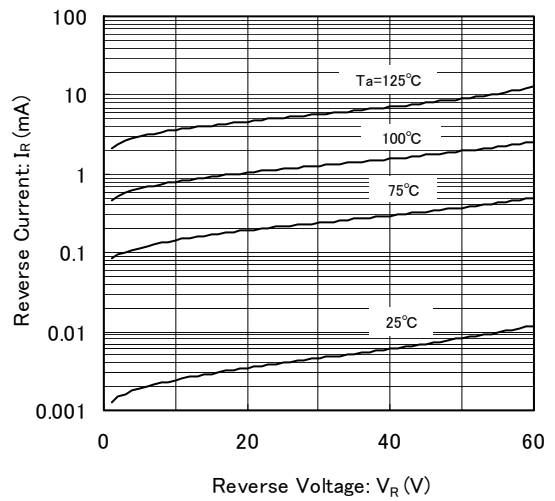

(3) Terminal Capacitance vs. Reverse Voltage

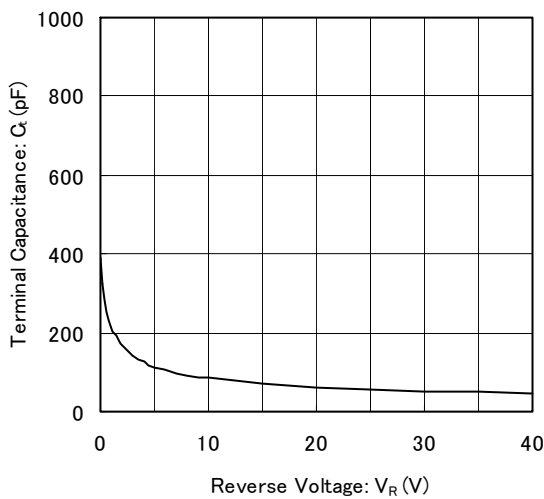

(4) Average Forward Current vs. Operating Temperature

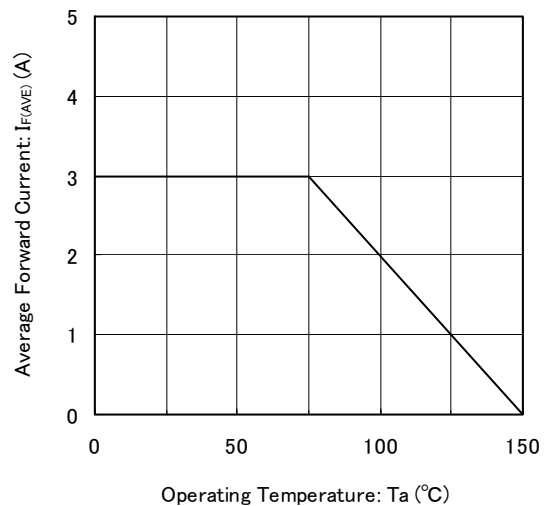

NOTES ON USE

1. Please use this IC within the absolute maximum ratings.

Even within the ratings, in case of high load use continuously such as high temperature, high voltage, high current and thermal stress may cause reliability degradation of the IC.

2. Torex places an importance on improving our products and their reliability.

We request that users incorporate fail-safe designs and post-aging protection treatment when using Torex products in their systems.

REFERENCE PATTERN LAYOUT

●SMA-PG

Unit : inch (mm)

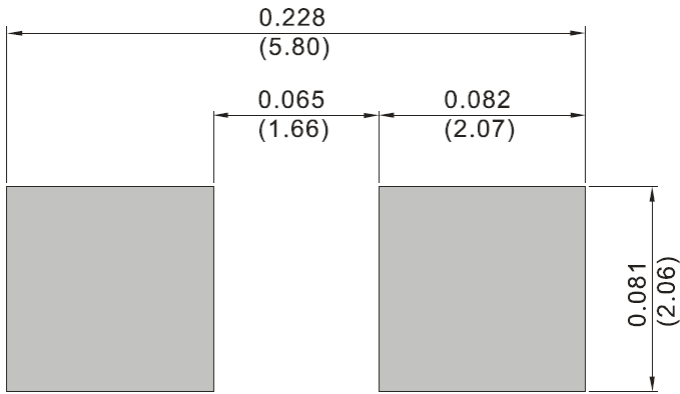

XBS306P11R-G

TAPING SPECIFICATIONS

●SMA-PG

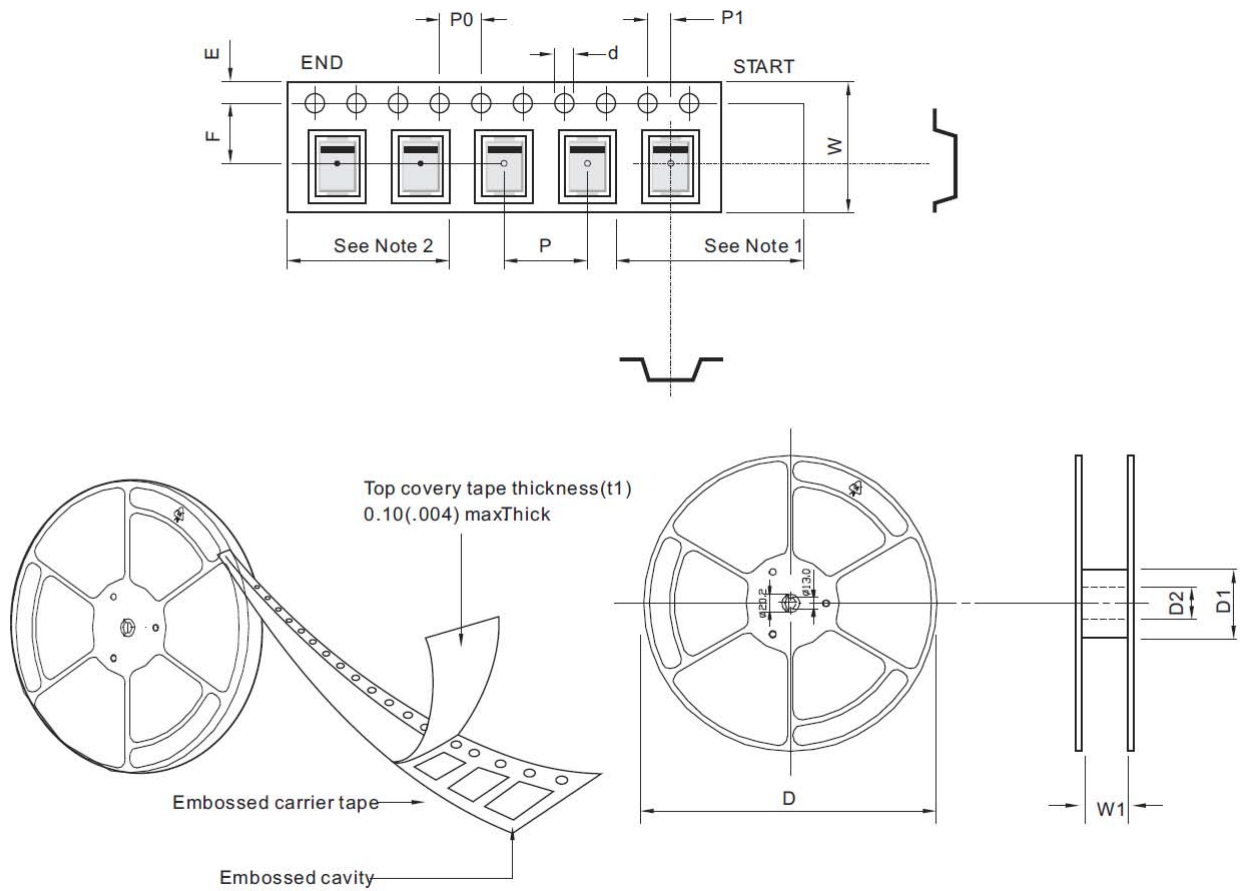

Note:

1. There shall be leader of 230mm minimum which may consist of carrier and or cover tape follower by a minimum of 160mm of carrier tape sealed with cover tape.
2. There shall be minimum of 160mm of empty component pockets sealed with cover tape.

SYMBOL	mm
d	1.55 ± 0.05
D	178.0 ± 2.0
D1	min. 50.0
D2	13.0 ± 0.2
E	1.75 ± 0.10
F	5.50 ± 0.10
P	4.00 ± 0.10
P0	4.00 ± 0.10
P1	2.00 ± 0.10
W	12.0 ± 0.3
W1	13.4 ± 1.0

1. The products and product specifications contained herein are subject to change without notice to improve performance characteristics. Consult us, or our representatives before use, to confirm that the information in this datasheet is up to date.
2. We assume no responsibility for any infringement of patents, patent rights, or other rights arising from the use of any information and circuitry in this datasheet.
3. Please ensure suitable shipping controls (including fail-safe designs and aging protection) are in force for equipment employing products listed in this datasheet.
4. The products in this datasheet are not developed, designed, or approved for use with such equipment whose failure or malfunction can be reasonably expected to directly endanger the life of, or cause significant injury to, the user.
(e.g. Atomic energy; aerospace; transport; combustion and associated safety equipment thereof.)
5. Please use the products listed in this datasheet within the specified ranges.
Should you wish to use the products under conditions exceeding the specifications, please consult us or our representatives.
6. We assume no responsibility for damage or loss due to abnormal use.
7. All rights reserved. No part of this datasheet may be copied or reproduced without the prior permission of TOREX SEMICONDUCTOR LTD.

TOREX SEMICONDUCTOR LTD.