

POWER MONITORING AND SWITCHING CONTROLLER FOR 3.3-V SRAM

FEATURES

- Power Monitoring and Switching for Non-Volatile Control of SRAMs
- Input Decoder Allows Control of 1 or 2 Banks of SRAM
- Write-Protect Control
- 3-V Primary Cell Input
- 3.3-V Operation
- Reset Output for System Power-On Reset
- Less than 20-ns Chip Enable Propagation Delay
- Small 16-Lead TSSOP Package

APPLICATIONS

- NVSRAM Modules
- Point-of-Sale Systems
- Facsimile, Printers and Photocopiers
- Internet Appliances
- Servers
- Medical Instrumentation and Industrial Products

DESCRIPTION

The CMOS bq2205 SRAM non-volatile controller with reset provides all the necessary functions for converting one or two banks of standard CMOS SRAM into non-volatile read/write memory.

A precision comparator monitors the 3.3-V VCC input for an out-of-tolerance condition. When out-of-tolerance is detected, the two conditioned chip-enable outputs are forced inactive to write-protect both banks of SRAM.

Power for the external SRAMs, VOUT, is switched from the VCC supply to the battery-backup supply as VCC decays. On a subsequent power-up, the VOUT supply is automatically switched from the backup supply to the VCC supply. The external SRAMs are write-protected until a power-valid condition exists. The reset output provides power-fail and power-on resets for the system. During power-valid operation, the input decoder, A, selects one of two banks of SRAM.

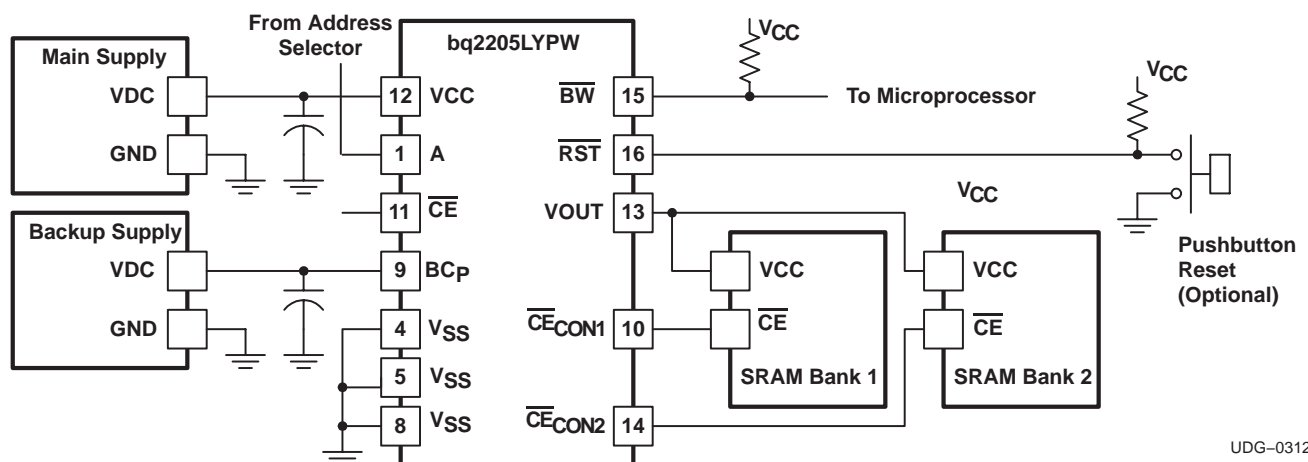

UDG-03129



Please be aware that an important notice concerning availability, standard warranty, and use in critical applications of Texas Instruments semiconductor products and disclaimers thereto appears at the end of this data sheet.



These devices have limited built-in ESD protection. The leads should be shorted together or the device placed in conductive foam during storage or handling to prevent electrostatic damage to the MOS gates.

ORDERING INFORMATION

T_A	OPERATION	PART NUMBER⁽¹⁾	SYMBOL
-20°C to 70°C	3.3 V	bq2205LYPW	bq2205LY

(1) The PW package is available taped and reeled. Add an R suffix to the device type (i.e. bq2205LYPWR) to order quantities of 2,000 devices per reel.

ABSOLUTE MAXIMUM RATINGS

over operating free-air temperature range unless otherwise noted⁽²⁾

		bq2205LY	UNIT
Input voltage range	V _{CC} , (wrt V _{SS})	-0.3 to 6.0	V
	BC _P , (wrt V _{SS})	-0.3 to 4.5	
	all other pins, (wrt V _{SS})	-0.3 to V _{CC} + 0.3	
Operating temperature range, T _A		-20 to 70	°C
Storage temperature, T _{stg}		-55 to 125	
Temperature under bias, T _{Jbias}		-40 to 85	
Lead temperature 1,6 mm (1/16 inch) from case for 10 seconds		300	

(2) Stresses beyond those listed under “absolute maximum ratings” may cause permanent damage to the device. These are stress ratings only, and functional operation of the device at these or any other conditions beyond those indicated under “recommended operating conditions” is not implied. Exposure to absolute-maximum-rated conditions for extended periods may affect device reliability.

RECOMMENDED OPERATING CONDITIONS

	MIN	MAX	UNIT
Supply voltage, V _{CC}	3.0	3.6	V
Supply voltage from backup cell, V _{BC}	2.0	4.0	
Low-level input voltage, V _{IL}	-0.3	0.8	
High-level input voltage, V _{IH}	2.2	V _{CC} + 0.3	
$\overline{\text{RST}}$ low-level input voltage, V _{IL}	-0.3	0.4	
$\overline{\text{RST}}$ high-level input voltage, V _{IH}	2.2	V _{CC} + 0.3	
Operating temperature range, T _A	-20	70	°C

ELECTRICAL CHARACTERISTICS(T_A = 25°C, V_{CC}(min) ≤ V_{CC} ≤ V_{CC}(max) unless otherwise noted)

PARAMETER	TEST CONDITIONS	MIN	TYP	MAX	UNIT
VCC supply current, I _{CC} (VCC)	V _{BC} > V _{CC} (MIN) CE = low CECONX = 0 mA		210	500	μA
Backup Battery Supply Current, I _{CC} (BC)	V _{BC} > V _{BC} (MIN), V _{CC} = 0 V CE = low CECONX = 0 mA		50	150	nA
Output voltage (VOUT)	I(VOUT) = 80 mA, V _{CC} > V(SO)	V _{CC} -0.3			V
	I(VOUT) = 100 μA, V _{CC} < V(SO)	V _{BC} -0.3			
Power fail detect voltage, V _{PFD}		2.85	2.9	2.95	
Supply switch-over voltage, V _{SO}	V _{BC} > V(PFD)		V _{PFD}		
	V _{BC} < V(PFD)		V _{BC}		
RST output voltage	I(RST) = 1 mA			0.4	
BW output voltage	I(BW) = 1 mA			0.4	
Input leakage current on A and CE pins		-1		1	μA
V _{oh} CE _{con1,2}	I _{oh} = 0.5 mA		2.4		V
V _{ol} CE _{con1,2}	I _{ol} = 2.0 mA		0.4		
Battery warning level V _{BW}	(1)			0.677xV _{CC}	
Capacitance					
Output capacitance	VOUT = 0 V			7	pF
Input capacitance	VOUT = 0 V			5	
Power-Down and Power-Up Timing, Refer to Figure 1 through 3					
VCC slew rate fall time, t _F	3.0 V to 0.0 V	300			μs
VCC slew rate rise time, t _R	V _{SO} to V _{PFD} (max)	100			
V _{PFD} to RST active, t _{RST} (reset active timeout period)		30		85	ms
Chip-enable recovery time, t _{CER}	(2)	30		85	
Chip-enable propagation delay time to external SRAM, t _{CED}	See Figure 2		15	25	ns
Push-button low time, t _{PBL}	RST pin		1		μs

(1) Battery warning level is detected on power up and the BW pin is latched at t_{CER} time after V_{CC} passes through V_{PFD} on power up.(2) Time during which external SRAM is write protected after V_{CC} passes through V_{PFD} on power up.

AC TEST CONDITIONS, INPUT PULSE LEVELS $0\text{ V} \leq V_{IN} \leq 3\text{ V}$, $t_R = t_F = 5\text{ NS}$

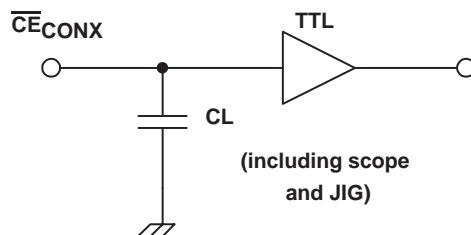

Figure 1. Output Load

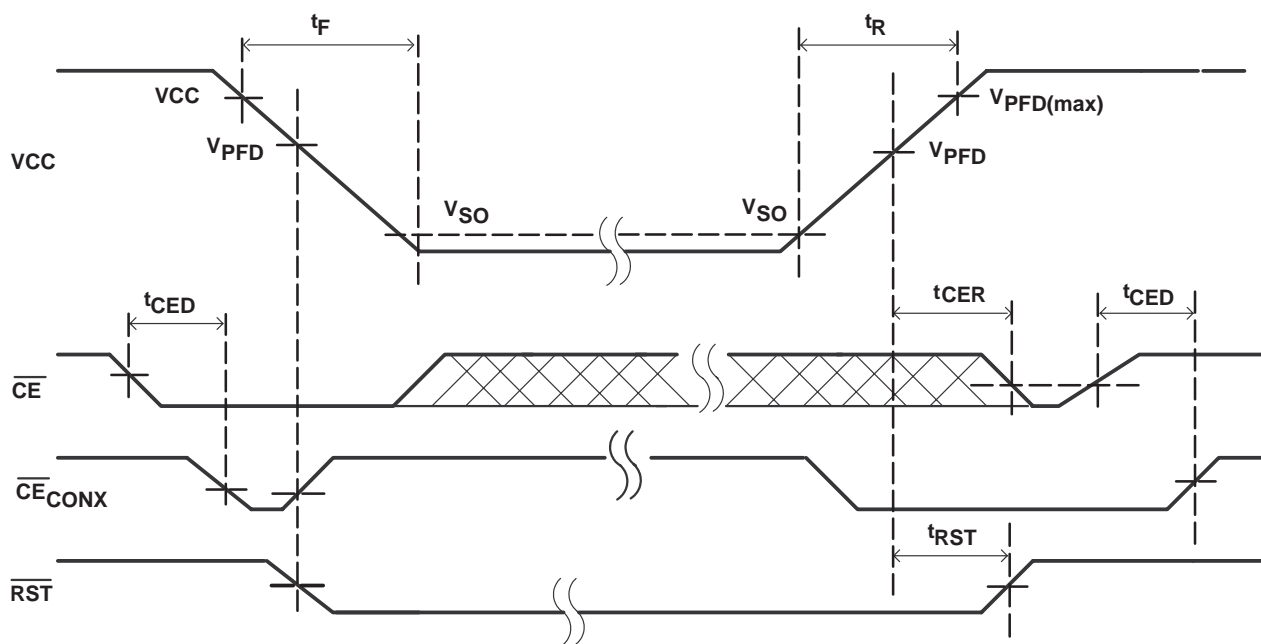

Figure 2. Power-Down/Power-Up Timing Diagram

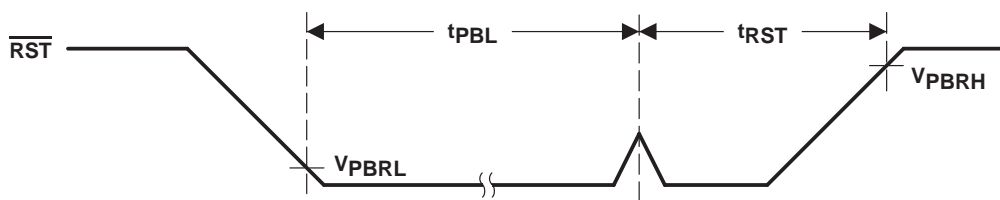
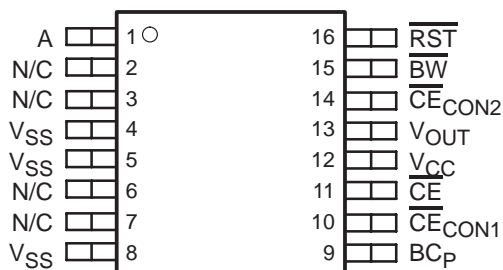

Figure 3. Push-Button Reset Timing

TERMINAL FUNCTIONS

NAME	TERMINAL	I/O	DESCRIPTION
	bq2205LY		
A	1	I	SRAM bank select input
BC _P	9	I	Backup supply input
$\overline{\text{BW}}$	15	O	Battery warning output (open-drain)
$\overline{\text{CE}}$	11	I	Chip enable input (active low)
$\overline{\text{CECON1}}$	10	O	Conditioned chip enable output 1
$\overline{\text{CECON2}}$	14	O	Conditioned chip enable output 2
N/C	2, 3, 6, 7	–	No connect. These pins must be left floating.
$\overline{\text{RST}}$	16	O	Power-up reset to system CPU output (open-drain)
V _{CC}	12	I	Main supply input
V _{OUT}	13	O	SRAM supply output
V _{SS}	4, 5, 8	–	Ground input

PW PACKAGE
(TOP VIEW)



N/C no connection

FUNCTIONAL DESCRIPTION

Two banks of CMOS static RAM can be battery-backed using the VOUT and conditioned chip-enable output pins from the bq2205. As the voltage input VCC slews down during a power failure, the two-conditioned chip enable outputs, \overline{CE}_{CON1} and \overline{CE}_{CON2} , are forced inactive independent of the chip enable input, \overline{CE} . This activity unconditionally write-protects the external SRAM as VCC falls to an out-of-tolerance threshold V_{PFD} . As the supply continues to fall past V_{PFD} , an internal switching device forces VOUT to the backup energy source. \overline{CE}_{CON1} and \overline{CE}_{CON2} are held high by the VOUT energy source.

During power-up, VOUT is switched back to the 3.3-V supply as VCC rises above the backup cell input voltage sourcing VOUT. Outputs \overline{CE}_{CON1} and \overline{CE}_{CON2} are held inactive for time t_{CER} after the power supply has reached V_{PFD} , independent of the \overline{CE} input, to allow for processor stabilization.

During power-valid operation, the \overline{CE} input is passed through to one of the two \overline{CE}_{CONx} outputs with a propagation delay of less than t_{CED} . The \overline{CE} input is output on one of the two \overline{CE}_{CONx} output pins; depending on the level of bank select input A. See truth table below.

Table 1. Truth Table

INPUT		OUTPUT	
\overline{CE}	A	\overline{CE}_{CON1}	\overline{CE}_{CON2}
H	x	H	H
L	L	L	H
L	H	H	L

Bank select input A is usually tied to a high-order address pin so that a large nonvolatile memory can be designed using lower-density memory devices. Non-volatility and decoding are achieved by hardware hookup as shown in the application diagram.

The \overline{RST} output can be used as the power-on reset for a microprocessor. Access to the external RAM may begin when \overline{RST} returns inactive.

BATTERY BACKUP INPUT

Backup energy source, BC_P input is provided on the bq2205 for use with an external primary cell. The primary cell input is designed to accept any 3-V primary battery (non-rechargeable), typically some type of lithium chemistry.

Power-Down and Power-Up Cycle

The bq2205 continuously monitors VCC for out-of-tolerance. During a power failure, when VCC falls below V_{PFD} , the bq2205 write-protects the external SRAM. The power source is switched to BC_P when V_{CC} is less than V_{PFD} and BC_P is greater than V_{PFD} , or when V_{CC} is less than BC_P and BC_P is less than V_{PFD} . When VCC is above V_{PFD} , the power source is V_{CC} . Write-protection continues for t_{CER} time after VCC rises above V_{PFD} .

An external CMOS static RAM is battery-backed using the VOUT and chip enable output pins from the bq2205. As the voltage input V_{CC} slews down during a power failure, the chip enable output, \overline{CE}_{CONx} , is forced inactive independent of the chip enable input \overline{CE} .

As the supply continues to fall past V_{PFD} , an internal switching device forces VOUT to the external backup energy source. \overline{CE}_{CONx} is held high by the VOUT energy source.

FUNCTIONAL DESCRIPTION

During power up, VOUT is switched back to the main supply as VCC rises above the backup cell input voltage sourcing VOUT. If $V_{PFD} < BC_P$ on the bq2205 the switch to the main supply occurs at V_{PFD} . \overline{CE}_{CONx} is held inactive for time t_{CER} after the power supply has reached V_{PFD} , independent of the \overline{CE} input, to allow for processor stabilization.

Power-On Reset

The bq2205 provides a power-on reset, which pulls the \overline{RST} pin low on power down and remains low on power up for t_{RST} after V_{CC} passes V_{PFD} . With valid battery voltage on BC_P , \overline{RST} remains valid for $V_{CC} = V_{SS}$. The pull-up resistor on this pin should not exceed 10 k Ω if a push button reset is used.

Battery Low Warning

The bq2205 checks the battery voltage on power-up. The threshold for the battery warning comparator is V_{BW} , and a low level is sensed after power valid on each power up and latched after t_{CER} time. The latched value is presented at \overline{BW} pin where a low indicates a low battery.

APPLICATION INFORMATION

PCB LAYOUT INFORMATION

It is important to pay special attention to the PCB layout. The following provides some guidelines:

- To obtain optimal performance, the decoupling capacitor from input terminals to V_{SS} should be placed as close as possible to the bq2205, with short trace runs to both signal and V_{SS} pins.
- All low-current V_{SS} connections should be kept separate from the high-current paths from the inputs supplies. Use a single-point ground technique incorporating both the small signal ground path and the power ground path.

MECHANICAL DATA

PW (R-PDSO-G**)

PLASTIC SMALL-OUTLINE PACKAGE

14 PINS SHOWN

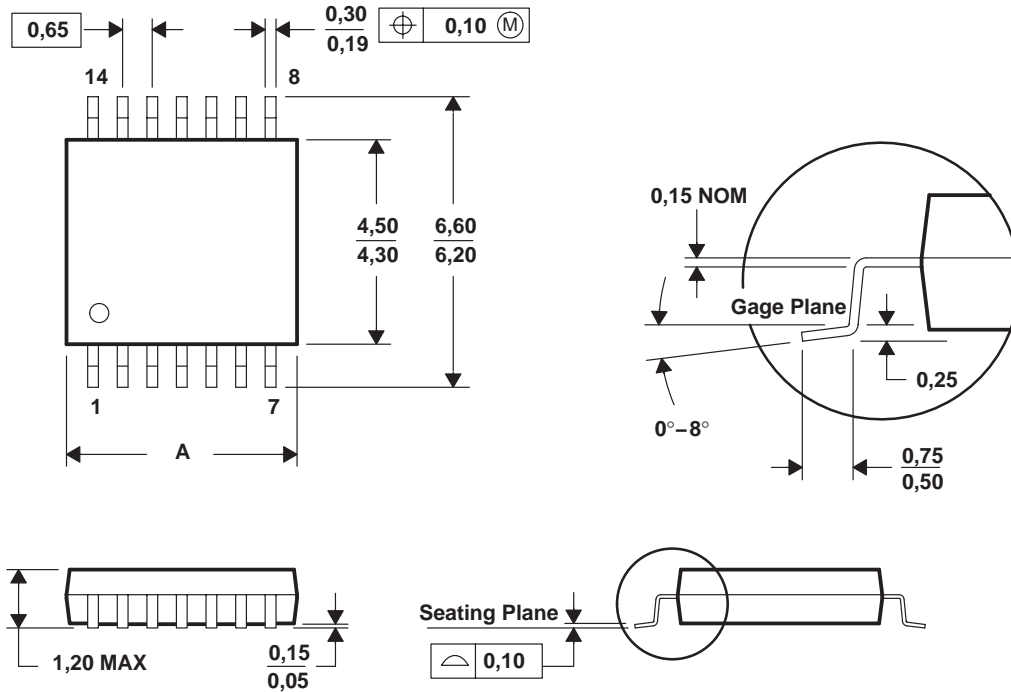

DIM \ PINS **	8	14	16	20	24	28
A MAX	3,10	5,10	5,10	6,60	7,90	9,80
A MIN	2,90	4,90	4,90	6,40	7,70	9,60

4040064/F 01/97

- NOTES: A. All linear dimensions are in millimeters.
 B. This drawing is subject to change without notice.
 C. Body dimensions do not include mold flash or protrusion not to exceed 0,15.
 D. Falls within JEDEC MO-153

PACKAGING INFORMATION

Orderable Device	Status (1)	Package Type	Package Drawing	Pins	Package Qty	Eco Plan (2)	Lead finish/ Ball material (6)	MSL Peak Temp (3)	Op Temp (°C)	Device Marking (4/5)	Samples
BQ2205LYPW	ACTIVE	TSSOP	PW	16	90	RoHS & Green	NIPDAU	Level-1-260C-UNLIM	-20 to 70	2205Y	Samples
BQ2205LYPWG4	ACTIVE	TSSOP	PW	16	90	RoHS & Green	NIPDAU	Level-1-260C-UNLIM	-20 to 70	2205Y	Samples
BQ2205LYPWR	ACTIVE	TSSOP	PW	16	2000	RoHS & Green	NIPDAU	Level-1-260C-UNLIM	-20 to 70	2205Y	Samples
BQ2205LYPWRG4	ACTIVE	TSSOP	PW	16	2000	RoHS & Green	NIPDAU	Level-1-260C-UNLIM	-20 to 70	2205Y	Samples

(1) The marketing status values are defined as follows:

ACTIVE: Product device recommended for new designs.

LIFEBUY: TI has announced that the device will be discontinued, and a lifetime-buy period is in effect.

NRND: Not recommended for new designs. Device is in production to support existing customers, but TI does not recommend using this part in a new design.

PREVIEW: Device has been announced but is not in production. Samples may or may not be available.

OBSELETE: TI has discontinued the production of the device.

(2) **RoHS:** TI defines "RoHS" to mean semiconductor products that are compliant with the current EU RoHS requirements for all 10 RoHS substances, including the requirement that RoHS substance do not exceed 0.1% by weight in homogeneous materials. Where designed to be soldered at high temperatures, "RoHS" products are suitable for use in specified lead-free processes. TI may reference these types of products as "Pb-Free".

RoHS Exempt: TI defines "RoHS Exempt" to mean products that contain lead but are compliant with EU RoHS pursuant to a specific EU RoHS exemption.

Green: TI defines "Green" to mean the content of Chlorine (Cl) and Bromine (Br) based flame retardants meet JS709B low halogen requirements of <=1000ppm threshold. Antimony trioxide based flame retardants must also meet the <=1000ppm threshold requirement.

(3) MSL, Peak Temp. - The Moisture Sensitivity Level rating according to the JEDEC industry standard classifications, and peak solder temperature.

(4) There may be additional marking, which relates to the logo, the lot trace code information, or the environmental category on the device.

(5) Multiple Device Markings will be inside parentheses. Only one Device Marking contained in parentheses and separated by a "-" will appear on a device. If a line is indented then it is a continuation of the previous line and the two combined represent the entire Device Marking for that device.

(6) Lead finish/Ball material - Orderable Devices may have multiple material finish options. Finish options are separated by a vertical ruled line. Lead finish/Ball material values may wrap to two lines if the finish value exceeds the maximum column width.

Important Information and Disclaimer:The information provided on this page represents TI's knowledge and belief as of the date that it is provided. TI bases its knowledge and belief on information provided by third parties, and makes no representation or warranty as to the accuracy of such information. Efforts are underway to better integrate information from third parties. TI has taken and

continues to take reasonable steps to provide representative and accurate information but may not have conducted destructive testing or chemical analysis on incoming materials and chemicals. TI and TI suppliers consider certain information to be proprietary, and thus CAS numbers and other limited information may not be available for release.

In no event shall TI's liability arising out of such information exceed the total purchase price of the TI part(s) at issue in this document sold by TI to Customer on an annual basis.

TAPE AND REEL INFORMATION

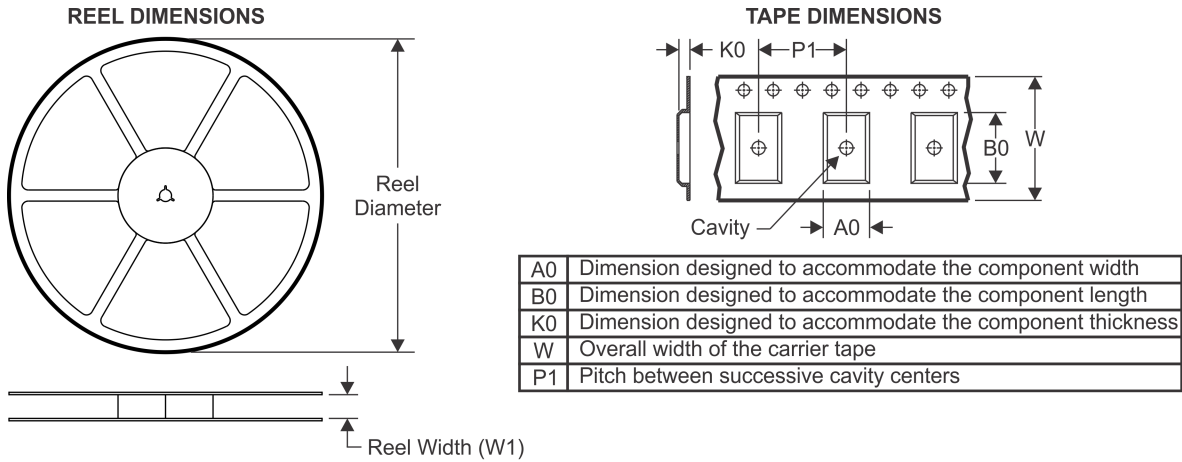

QUADRANT ASSIGNMENTS FOR PIN 1 ORIENTATION IN TAPE



*All dimensions are nominal

Device	Package Type	Package Drawing	Pins	SPQ	Reel Diameter (mm)	Reel Width W1 (mm)	A0 (mm)	B0 (mm)	K0 (mm)	P1 (mm)	W (mm)	Pin1 Quadrant
BQ2205LYPWR	TSSOP	PW	16	2000	330.0	12.4	6.9	5.6	1.6	8.0	12.0	Q1

TAPE AND REEL BOX DIMENSIONS



*All dimensions are nominal

Device	Package Type	Package Drawing	Pins	SPQ	Length (mm)	Width (mm)	Height (mm)
BQ2205LYPWR	TSSOP	PW	16	2000	350.0	350.0	43.0



NOTES:

1. All linear dimensions are in millimeters. Any dimensions in parenthesis are for reference only. Dimensioning and tolerancing per ASME Y14.5M.
2. This drawing is subject to change without notice.
3. This dimension does not include mold flash, protrusions, or gate burrs. Mold flash, protrusions, or gate burrs shall not exceed 0.15 mm per side.
4. This dimension does not include interlead flash. Interlead flash shall not exceed 0.25 mm per side.
5. Reference JEDEC registration MO-153.

EXAMPLE BOARD LAYOUT

PW0016A

TSSOP - 1.2 mm max height

SMALL OUTLINE PACKAGE



LAND PATTERN EXAMPLE
EXPOSED METAL SHOWN
SCALE: 10X



SOLDER MASK DETAILS

4220204/A 02/2017

NOTES: (continued)

- 6. Publication IPC-7351 may have alternate designs.
- 7. Solder mask tolerances between and around signal pads can vary based on board fabrication site.

EXAMPLE STENCIL DESIGN

PW0016A

TSSOP - 1.2 mm max height

SMALL OUTLINE PACKAGE



SOLDER PASTE EXAMPLE
BASED ON 0.125 mm THICK STENCIL
SCALE: 10X

4220204/A 02/2017

NOTES: (continued)

8. Laser cutting apertures with trapezoidal walls and rounded corners may offer better paste release. IPC-7525 may have alternate design recommendations.
9. Board assembly site may have different recommendations for stencil design.

IMPORTANT NOTICE AND DISCLAIMER

TI PROVIDES TECHNICAL AND RELIABILITY DATA (INCLUDING DATASHEETS), DESIGN RESOURCES (INCLUDING REFERENCE DESIGNS), APPLICATION OR OTHER DESIGN ADVICE, WEB TOOLS, SAFETY INFORMATION, AND OTHER RESOURCES "AS IS" AND WITH ALL FAULTS, AND DISCLAIMS ALL WARRANTIES, EXPRESS AND IMPLIED, INCLUDING WITHOUT LIMITATION ANY IMPLIED WARRANTIES OF MERCHANTABILITY, FITNESS FOR A PARTICULAR PURPOSE OR NON-INFRINGEMENT OF THIRD PARTY INTELLECTUAL PROPERTY RIGHTS.

These resources are intended for skilled developers designing with TI products. You are solely responsible for (1) selecting the appropriate TI products for your application, (2) designing, validating and testing your application, and (3) ensuring your application meets applicable standards, and any other safety, security, or other requirements. These resources are subject to change without notice. TI grants you permission to use these resources only for development of an application that uses the TI products described in the resource. Other reproduction and display of these resources is prohibited. No license is granted to any other TI intellectual property right or to any third party intellectual property right. TI disclaims responsibility for, and you will fully indemnify TI and its representatives against, any claims, damages, costs, losses, and liabilities arising out of your use of these resources.

TI's products are provided subject to TI's Terms of Sale (www.ti.com/legal/termsofsale.html) or other applicable terms available either on ti.com or provided in conjunction with such TI products. TI's provision of these resources does not expand or otherwise alter TI's applicable warranties or warranty disclaimers for TI products.

Mailing Address: Texas Instruments, Post Office Box 655303, Dallas, Texas 75265
Copyright © 2020, Texas Instruments Incorporated