

ISL88705, ISL88706, ISL88707, ISL88708, ISL88716, ISL88813

FN8092
Rev 6.00
November 30, 2015

Designed with high reset threshold accuracy and low power consumption, the ISL88705, ISL88706, ISL88707, ISL88708, ISL88716 and ISL88813 devices are microprocessor supervisors that are designed to monitor power-supply and battery functions in microprocessor systems. They can help to lower system cost, reduce board space requirements and increase the reliability of systems.

These devices provide essential functions such as supply voltage supervision by asserting a reset output during power-up and power-down as well as during brownout conditions. An auxiliary voltage monitor is provided for detecting power failures warning the system of low battery conditions or presence detection. In addition, an independent watchdog timer helps to monitor microprocessor activity every 1.6s (typical). An active-low manual reset is offered and reset signals remain asserted until V_{DD} returns to proper operating levels.

Users can increase the nominal 200ms power-on reset time-out delay by adding an external capacitor to the C_{POR} pin on the ISL88707 and ISL88708.

Features

- Fixed-Voltage Options Allow Precise Monitoring of +3.0V, +3.3V, and +5.0V Power Supplies
- Additional Voltage Monitor for Power-Fail Detection or Low-Battery Warning
 - Monitors Voltages Down to 1.25V
 - Adjustable Power-Fail Input Threshold
- Watchdog Timer Capability With 1.6s Time-out
- Both RST and \overline{RST} Outputs Available
- 140ms Minimum Reset Pulse Width with Option to Customize Using an External Capacitor
- Manual Reset Input on all Devices
- Reset Signal Valid Down to $V_{DD} = 1V$
- Accurate $\pm 1.8\%$ Voltage Threshold
- Immune to Power-Supply Transients
- Ultra Low 10 μ A Maximum Supply Current at 3V
- Pb-Free (RoHS Compliant)

Applications

- Portable/Battery Powered Equipment
- Notebook/Desktop Computer Systems
- Designs Using DSPs, Microcontrollers or Microprocessors
- Controllers
- Intelligent Instruments
- Communications Systems
- Industrial Equipment

Pinouts

ISL88705, ISL88706
(8 LD SOIC)
(PDIP - NO LONGER AVAILABLE)
TOP VIEW



ISL88716, ISL88813
(8 LD SOIC)
(PDIP - NO LONGER AVAILABLE)
TOP VIEW

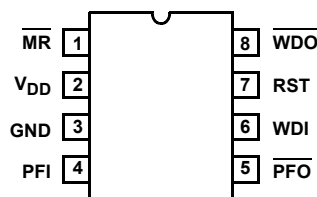

ISL88707, ISL88708
(8 LD SOIC)
(PDIP - NO LONGER AVAILABLE)
TOP VIEW



Ordering Information

PART NUMBER (Note)	PART MARKING	V _{TH}	TEMP RANGE (°C)	PACKAGE (RoHS Compliant)	PKG. DWG. #
ISL88705IP846Z (No longer available, recommended replacement: ISL88705IB846Z)	88705 146Z	4.64V	-40 to +85	8 Ld PDIP**	MDP0031
ISL88813IP846Z (No longer available, recommended replacement: ISL88813IB846Z)	88813 146Z	4.64V	-40 to +85	8 Ld PDIP**	MDP0031
ISL88707IP846Z (No longer available, recommended replacement: ISL88707IB846Z)	88707 146Z	4.64V	-40 to +85	8 Ld PDIP**	MDP0031
ISL88706IP844Z (No longer available, recommended replacement: ISL88706IB844Z)	88706 144Z	4.38V	-40 to +85	8 Ld PDIP**	MDP0031
ISL88708IP844Z (No longer available, recommended replacement: ISL88708IB844Z)	88708 144Z	4.38V	-40 to +85	8 Ld PDIP**	MDP0031
ISL88706IP831Z (No longer available, recommended replacement: ISL88706IB831Z)	88706 131Z	3.09V	-40 to +85	8 Ld PDIP**	MDP0031
ISL88708IP831Z (No longer available, recommended replacement: ISL88708IB831Z)	88708 131Z	3.09V	-40 to +85	8 Ld PDIP**	MDP0031
ISL88706IP829Z (No longer available, recommended replacement: ISL88706IB829Z)	88706 129Z	2.92V	-40 to +85	8 Ld PDIP**	MDP0031
ISL88708IP829Z (No longer available, recommended replacement: ISL88708IB829Z)	88708 129Z	2.92V	-40 to +85	8 Ld PDIP**	MDP0031
ISL88706IP826Z (No longer available, recommended replacement: ISL88706IB826Z)	88706 126Z	2.63V	-40 to +85	8 Ld PDIP**	MDP0031
ISL88716IP826Z (No longer available, recommended replacement: ISL88716IB826Z)	88716 126Z	2.63V	-40 to +85	8 Ld PDIP**	MDP0031
ISL88708IP826Z (No longer available, recommended replacement: ISL88708IB826Z)	88708 126Z	2.63V	-40 to +85	8 Ld PDIP**	MDP0031
ISL88705IB846Z*	88705 146Z	4.64V	-40 to +85	8 Ld SOIC	M8.15
ISL88813IB846Z*	88813 146Z	4.64V	-40 to +85	8 Ld SOIC	M8.15
ISL88707IB846Z*	88707 146Z	4.64V	-40 to +85	8 Ld SOIC	M8.15
ISL88706IB844Z*	88706 144Z	4.38V	-40 to +85	8 Ld SOIC	M8.15
ISL88708IB844Z*	88708 144Z	4.38V	-40 to +85	8 Ld SOIC	M8.15
ISL88706IB831Z*	88706 131Z	3.09V	-40 to +85	8 Ld SOIC	M8.15
ISL88708IB831Z*	88708 131Z	3.09V	-40 to +85	8 Ld SOIC	M8.15
ISL88706IB829Z*	88706 129Z	2.92V	-40 to +85	8 Ld SOIC	M8.15
ISL88708IB829Z*	88708 129Z	2.92V	-40 to +85	8 Ld SOIC	M8.15
ISL88706IB826Z*	88706 126Z	2.63V	-40 to +85	8 Ld SOIC	M8.15
ISL88716IB826Z*	88716 126Z	2.63V	-40 to +85	8 Ld SOIC	M8.15
ISL88708IB826Z*	88708 126Z	2.63V	-40 to +85	8 Ld SOIC	M8.15
ISL88705EVAL1	Evaluation Board				

*Add "-TK" suffix for Tape and Reel Packaging. Please refer to TB347 for details on reel specifications.

**Pb-free PDIPs can be used for through-hole wave solder processing only. They are not intended for use in Reflow solder processing applications.

NOTE: These Intersil Pb-free plastic packaged products employ special Pb-free material sets, molding compounds/die attach materials, and 100% matte tin plate plus anneal (e3 termination finish, which is RoHS compliant and compatible with both SnPb and Pb-free soldering operations). Intersil Pb-free products are MSL classified at Pb-free peak reflow temperatures that meet or exceed the Pb-free requirements of IPC/JEDEC J STD-020.

Functional Block Diagrams



ISL88705, ISL88706



ISL88716, ISL88813



ISL88707, ISL88708

Pin Descriptions

ISL88705, ISL88706	ISL88716, ISL88813	ISL88707, ISL88708	NAME	DESCRIPTION
1	1	1	$\overline{\text{MR}}$	Manual Reset Input. A reset signal is generated when this input is pulled low. The $\overline{\text{MR}}$ input is an active low debounced input to which a user can connect a push-button to add manual reset capability or drive with a signal. The MR pin has an internal 20k Ω pull-up.
2	2	2	V_{DD}	Power Supply Terminal. The voltage at this pin is compared against an internal factory-programmed voltage trip point, V_{TH1} . A reset is first asserted when the device is initially powered up to ensure that the power supply has stabilized. Thereafter, reset is again asserted whenever V_{DD} falls below V_{TH1} . The device is designed with hysteresis to help prevent chattering due to noise and is immune to brief power-supply transients. The voltage threshold V_{TH1} is specified in the part number suffix.
3	3	3	GND	Ground Connection
4	4	4	PFI	Power-Fail Input This is an auxiliary monitored voltage input with a 1.25V threshold that causes $\overline{\text{PFO}}$ state to follow the PFI input state.
5	5	5	$\overline{\text{PFO}}$	Power-Fail Output. This output goes high if the voltage on PFI is greater than 1.25V, otherwise $\overline{\text{PFO}}$ stays low.
		6	C_{POR}	Adjustable POR Time-out Delay Input. Connecting an external capacitor from C_{POR} to ground allows the user to increase the Power-On Reset time-out (t_{POR}) from the nominal 200ms.
6	6		WDI	Watchdog Input. The Watchdog Input takes an input from a microprocessor and ensures that it periodically toggles the WDI pin, otherwise the internal nominal 1.6s watchdog timer runs out, then reset is asserted and WDO is pulled low. The internal Watchdog Timer is cleared whenever the WDI sees a rising or falling edge or the device is manually reset. Floating WDI or connecting WDI to a high-impedance three-state buffer disables the watchdog feature.
7		7	$\overline{\text{RST}}$	Active-Low Reset Output. The $\overline{\text{RST}}$ output is an active low output with an internal PMOS pull-up that is pulled low to GND when reset is asserted. Reset is asserted whenever: <ol style="list-style-type: none"> 1. The device is first powered up 2. V_{DD} falls below its minimum voltage sense level or 3. $\overline{\text{MR}}$ is asserted. The reset output continues to be asserted for typically 200ms after V_{DD} rises above the reset threshold or $\overline{\text{MR}}$ input goes from low to high. A watchdog time-out will not trigger a reset unless WDO is connected to $\overline{\text{MR}}$.
	7	8	RST	Active-High Reset Output. The RST pin functions identically to its complementary $\overline{\text{RST}}$ output but is an active high push-pull output. RST is set high to V_{DD} when reset is asserted. See the RST in "Pin Descriptions" on page 4 for more details on conditions that cause a reset.
8	8		$\overline{\text{WDO}}$	Watchdog Output. This output is pulled low when the nominal 1.6s internal Watchdog Timer expires and periodically resets until the watchdog is cleared. WDO also goes low during low V_{DD} conditions. Whenever V_{DD} is below the reset threshold, WDO stays low. However, unlike RESET, WDO does not have a minimum pulse width. As soon as V_{DD} rises above the reset threshold, WDO goes high with no delay.

Absolute Maximum Ratings

Temperature Under Bias-40°C to +125°C
 Storage Temperature-65°C to +150°C
 Voltage on any Pin with Respect to GND-1.0V to +7V
 DC Output Current 5mA

Recommended Operating Conditions

Temperature Range (Industrial)-40°C to +85°C

Thermal Information

Thermal Resistance (Typical, Note 1) θ_{JA} (°C/W)
 PDIP Package* (4-layer test board) 83
 SOIC Package (4-layer test board) 110
 Pb-free Reflow Profilesee link below
<http://www.intersil.com/pbfree/Pb-FreeReflow.asp>
 *Pb-free PDIPs can be used for through hole wave solder processing only. They are not intended for use in Reflow solder processing applications.

CAUTION: Do not operate at or near the maximum ratings listed for extended periods of time. Exposure to such conditions may adversely impact product reliability and result in failures not covered by warranty.

NOTE:

1. θ_{JA} is measured with the component mounted on a high effective thermal conductivity test board in free air. See Tech Brief TB379 for details.

Electrical Specifications Over the recommended operating conditions unless otherwise specified. Parameters with MIN and/or MAX limits are 100% tested at +25°C, unless otherwise specified. Temperature limits established by characterization and are not production tested.

SYMBOL	PARAMETER	CONDITIONS	MIN	TYP	MAX	UNITS
V _{DD}	Supply Voltage Range		2.0		5.5	V
I _{DD}		V _{DD} = 5V, WDT Inactive		10	19	μA
		V _{DD} = 3V, WDT Inactive		8	10	μA
I _{LI}	Input Leakage Current (PFI)				100	nA
I _{LO}	Output Leakage Current				100	nA
VOLTAGE THRESHOLDS						
V _{TH1}	Fixed V _{DD} Voltage Trip Point		4.556	4.640	4.724	V
			4.301	4.380	4.459	V
			3.034	3.090	3.146	V
			2.867	2.920	2.973	V
			2.583	2.630	2.677	V
V _{TH1HYST}	Hysteresis at V _{TH1} Input Temperature = +25°C	V _{TH1} = 4.64V		46		mV
		V _{TH1} = 4.38V		44		mV
		V _{TH1} = 3.09V		37		mV
		V _{TH1} = 2.92V		29		mV
		V _{TH1} = 2.63V		31		mV
RST AND $\overline{\text{RST}}$						
V _{OL}	Reset Output Voltage Low	V _{DD} ≥ 3.3V, Sinking 2.5mA		0.05	0.40	V
		V _{DD} < 3.3V, Sinking 1.5mA		0.05	0.40	V
V _{OH}	RST Output Voltage High	V _{DD} ≥ 3.3V, Sourcing 2.5mA	V _{DD} - 0.6	V _{DD} - 0.4		V
		V _{DD} < 3.3V, Sourcing 1.5mA	V _{DD} - 0.6	V _{DD} - 0.4		V
	$\overline{\text{RST}}$ Output Voltage High	V _{DD} ≥ 3.3V, Sourcing 0.8mA	V _{DD} - 0.6	V _{DD} - 0.4		V
		V _{DD} < 3.3V, Sourcing 0.5mA	V _{DD} - 0.6	V _{DD} - 0.4		V
t _{RPD}	V _{TH} to Reset Asserted Delay			45		μs
t _{POR}	POR Time-Out Delay	C _{POR} is open	140	200	260	ms
C _{LOAD}	Load Capacitance on Reset Pins			5		pF

Electrical Specifications Over the recommended operating conditions unless otherwise specified. Parameters with MIN and/or MAX limits are 100% tested at +25°C, unless otherwise specified. Temperature limits established by characterization and are not production tested. **(Continued)**

SYMBOL	PARAMETER	CONDITIONS	MIN	TYP	MAX	UNITS
MANUAL RESET						
V _{MRL}	$\overline{\text{MR}}$ Input Voltage Low				0.8	V
V _{MRH}	$\overline{\text{MR}}$ Input Voltage High		V _{DD} - 0.6			V
t _{MR}	$\overline{\text{MR}}$ Minimum Pulse Width		550			ns
R _{PU}	Internal $\overline{\text{MR}}$ Pull-Up Resistor			20		kΩ
WATCHDOG TIMER (Note 2)						
t _{WDT}	Watchdog Time-out Period		1.0	1.6	2.0	s
t _{WDPS}	WDI Minimum Pulse Width		100			ns
V _{IL}	Watchdog Input Voltage Low				0.3 x V _{DD}	V
V _{IH}	Watchdog Input Voltage High		0.7 x V _{DD}			V
V _{WDOL}	$\overline{\text{WDO}}$ Output Voltage Low	V _{DD} ≥ 3.3V, Sinking 2.5mA		0.05	0.40	V
		V _{DD} < 3.3V, Sinking 1.5mA		0.05	0.40	V
V _{WDOH}	$\overline{\text{WDO}}$ Output Voltage High	V _{DD} ≥ 3.3V, Sourcing 2.5mA	V _{DD} - 0.6	V _{DD} - 0.4		V
		V _{DD} < 3.3V, Sourcing 1.5mA	V _{DD} - 0.6	V _{DD} - 0.4		V
I _{WDT}	Watchdog Input Current				1	μA
POWER-FAIL DETECTION						
V _{THPFI}	PFI Input Threshold Voltage	$\overline{\text{MR}}$ = Open	1.20	1.25	1.30	V
PFIV _{THHYST}	Hysteresis Voltage			20		mV
V _{PFOL}	PFO Output Voltage Low	V _{DD} ≥ 3.3V, Sinking 2.5mA		0.05	0.40	V
		V _{DD} < 3.3V, Sinking 1.5mA		0.05	0.40	V
V _{PF0H}	PFO Output Voltage High	V _{DD} ≥ 3.3V, Sourcing 2.5mA	V _{DD} - 0.6	V _{DD} - 0.4		V
		V _{DD} < 3.3V, Sourcing 1.5mA	V _{DD} - 0.6	V _{DD} - 0.4		V

NOTE:

2. Applies to ISL88705, ISL88706, ISL88716, and ISL88813.

Principles of Operation

The ISL88705, ISL88706, ISL88707, ISL88708, ISL88716, ISL88813 devices provide those functions needed for monitoring critical voltages such as power-supply and battery functions in microprocessor systems. Features of these supervisors include Power-On Reset control, Supply Voltage Supervision, Power-Fail Detection and Manual Reset Assertion. The integration of all these features along with high reset threshold accuracy and low power consumption make these devices ideal for portable or battery-powered equipment.

Power-On Reset (POR)

Applying power to the device activates a POR circuit which asserts reset (i.e. RST goes high while $\overline{\text{RST}}$ goes low). These signals provide several benefits:

- It prevents the system microprocessor from starting to operate with insufficient voltage.
- It prevents the processor from operating prior to stabilization of the oscillator.
- It ensures that the monitored device is held out of operation until internal registers are properly loaded.
- It allows time for an FPGA to download its configuration prior to initialization of the circuit.

The reset signals remain active until V_{DD} rises above the minimum voltage sense level for time period t_{POR}. This ensures that the supply voltage has stabilized to sufficient operating levels.



FIGURE 1. POWER-SUPPLY MONITORING TIMING DIAGRAM (WDI TRI-STATED)

Low Voltage Monitoring

These devices monitor both the voltage level of V_{DD} and an auxiliary voltage on PFI.

When IC is initially biased reset is asserted until the V_{DD} voltage is greater than the specific IC fixed-voltage trip point for the t_{POR} duration of 200ms. At any subsequent time that V_{DD} does not exceed its voltage threshold, reset is once again asserted, i.e. \overline{RST} is high and \overline{RST} is low (see Figure 1).

Power Failure Monitor

These devices also have a Power-Failure Monitor that helps to monitor an additional critical voltage on the Power-Fail Input (PFI) pin. For example, the PFI pin could be used to provide an early power-fail warning, detect a low-battery condition, presence detection or simply monitor a power supply other than +5V. The 1.25V threshold detector can be adjusted using an external resistor divider network to provide custom voltage monitoring of voltages greater than 1.25V, according to Equation 1 (see Figure 2).

$$PFI V_{TH} = 1.25 \left(\frac{R_1 + R_2}{R_2} \right) \quad (EQ. 1)$$

\overline{PFO} goes low whenever PFI is less than the 1.25V (or user-set) threshold voltage.

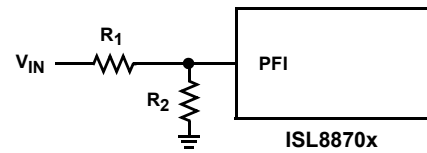

FIGURE 2. CUSTOM V_{TH} WITH RESISTOR DIVIDER ON PFI

If using a voltage divider on the PFI input to critique an external voltage and intending to use the \overline{MR} input to initiate resets then avoid having the PFI voltage less than $PFI V_{th} + 2.2V$ as unintended PFO transition may occur when \overline{MR} is transitioning high.

Adjusting t_{POR}

On the ISL88707 and ISL88708, users can adjust the Power-On Reset time-out delay (t_{POR}) to many times the nominal t_{POR} of 200ms. To do this, connect a capacitor between C_{POR} and ground (see Figure 3). For example, connecting a 50pF capacitor to C_{POR} will increase t_{POR} from 200ms to ~1.4s. Care should be taken in PCB layout and capacitor placement in order to reduce stray capacitance as much as possible, which contributes to t_{POR} error.



ISL88707, ISL88708



FIGURE 3. ADJUSTING t_{POR} WITH A CAPACITOR

Manual Reset

The manual-reset input ($\overline{\text{MR}}$) allows the user to trigger a reset by using a push-button switch. The $\overline{\text{MR}}$ input is an active low debounced input. By connecting a push-button directly from $\overline{\text{MR}}$ to ground, the designer adds manual system reset capability (see Figure 4). Reset is asserted if the $\overline{\text{MR}}$ pin is pulled low to less than 100mV for the minimum $\overline{\text{MR}}$ pulse width or longer while the push-button is closed. After $\overline{\text{MR}}$ is released, the reset outputs remain asserted for t_{POR} (200ms) and then released.

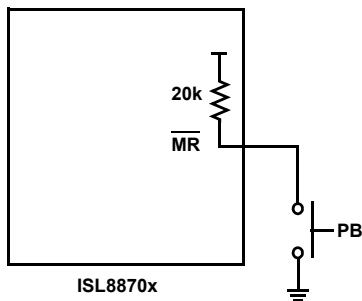

FIGURE 4. CONNECTING A MANUAL RESET PUSH-BUTTON

Watchdog Timer

The Watchdog Timer circuit checks microprocessor activity by monitoring the WDI input pin. The microprocessor must periodically toggle the WDI pin within t_{WDT} (typically ~1.6s), otherwise the $\overline{\text{WDO}}$ pin pulls low (see Figure 5). The $\overline{\text{WDO}}$ then signals reset periodically (typically ~1.9s) for ~220ms until the WDI is again toggled. Internally, the 1.6s timer is cleared by either a reset or by toggling the WDI input, which can detect pulses longer than 50ns.

Whenever there is a low-voltage V_{DD} condition, $\overline{\text{WDO}}$ goes low. Unlike the reset outputs, however, $\overline{\text{WDO}}$ does not have a minimum reset pulse width (t_{POR}). $\overline{\text{WDO}}$ goes high as soon as V_{DD} rises above its voltage trip point (see Figure 5). With WDI open or connected to a tristated high impedance input, the Watchdog Timer is disabled and only pulls low when V_{DD} < V_{TH1}.



FIGURE 5. WATCHDOG TIMING DIAGRAM

Typical Performance Curves



FIGURE 6. I_{DD} vs TEMPERATURE



FIGURE 7. V_{TH1} vs TEMPERATURE FOR 5V SUPPLY



FIGURE 8. V_{TH1} vs TEMPERATURE < 5V SUPPLY



FIGURE 9. V_{THPFI} vs TEMPERATURE

Typical Performance Curves (Continued)

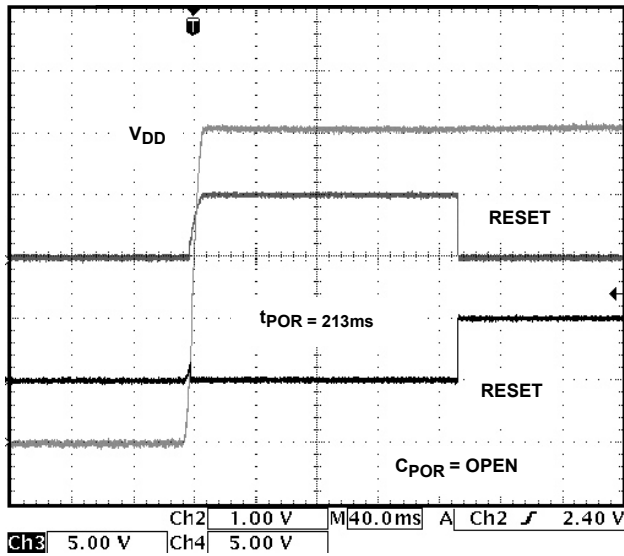

FIGURE 10. RESET AND $\overline{\text{RESET}}$ ASSERTION

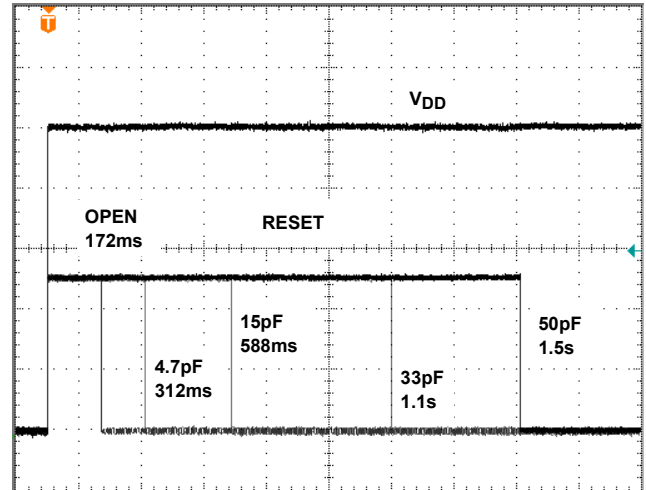

FIGURE 11. RESET ASSERTION vs CPOR

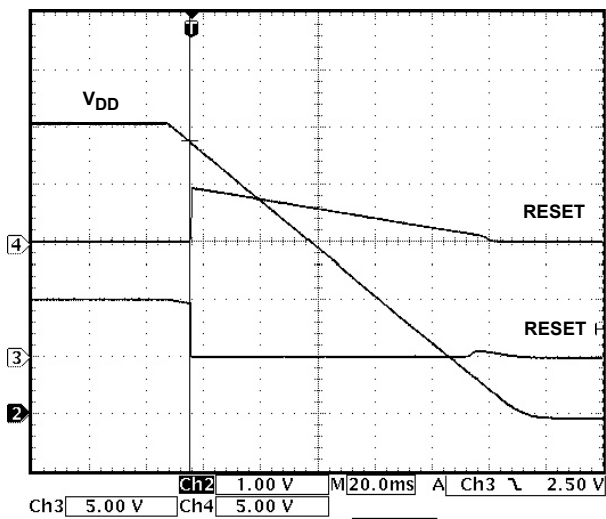

FIGURE 12. RESET AND $\overline{\text{RESET}}$ DEASSERTION

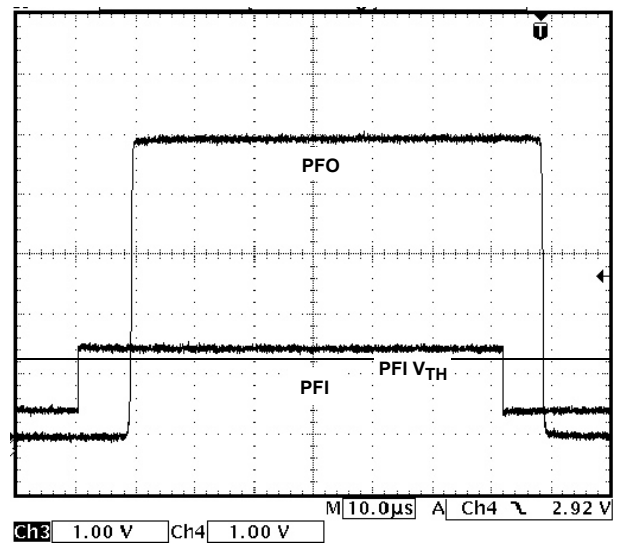

FIGURE 13. 5V PFI TO PFO RESPONSE

Typical Performance Curves (Continued)



FIGURE 14. 5V OV/UV MONITORING

ISL88705EVAL1 and Applications

The ISL88705EVAL1 supports all six of the ISL88705, ISL88706, ISL88707, ISL88708, ISL88716, ISL88813 devices, enabling evaluation of basic functional operation and common application implementations. Figures 15 and 17 illustrate the ISL88705EVAL1 in photographic and schematic forms respectively.

The ISL88705EVAL1 is divided into two banks; each bank having one each of the three available pinouts. The top bank is fully populated and immediately usable whereas the bottom bank is unpopulated. Samples of other sample variants can be evaluated singularly or in combination with any other variant to provide a specific voltage monitoring solution. The left position has the ISL88705IB846Z monitoring the V_{DD} rail voltage for a minimum of 4.64V with reset signaling. In addition, the power fail input (PFI) is being compared to the internal PFI voltage reference of 1.25V and the power fail output (\overline{PFO}) will report the PFI condition. This feature can be used for monitoring an auxiliary voltage, providing an early warning of a brown-out or power failure or presence detection in a system.

The middle position has the ISL88813IB846Z installed and is set-up as a 5V window detector with jumper J1 installed. The V_{DD} monitors for UV and the PFI for OV via the R_3 , R_4 divider. The \overline{PFO} output is inverted and connected to the manual reset input (MR) via U4. Hence, a reset signal is generated when $4.64V < V_{DD} > 5.38V$. With J1 removed, the \overline{PFO} will be an OV indicator but no reset signal will be generated. Both of these positions share a common Watchdog input (WDI) signal although each has its own Watchdog output (\overline{WDO}).

The right position has the ISL88707IB846Z and is set-up as a +12V and +5V UV monitor with reset signal. The PFI allows monitoring of any voltage above the 1.25V PFI reference and with a resistor divider this is used to monitor the 12V. The ISL88707 and ISL88708 have the unique feature of an adjustable time to reset (t_{POR}) signal generation capability via the C_{POR} pin with an external capacitor to GND. This evaluation platform has an adjustable SMD capacitor, C_4 (8pF to 45pF) that allows easy evaluation of this feature. Also unique to the ISL88707 and ISL88708 are both the RESET and \overline{RESET} outputs, all other variants having only one or the other.

Figures 10, 11, 12, 13 and 14 illustrate the basic IC functions and performance of the 3 implementations.



FIGURE 15. ISL88705EVAL1

Bipolar Voltage Sensing

Any of the ISL88705, ISL88706, ISL88707, ISL88708, ISL88716, ISL88813 devices can be used to sense and report the presence of both a positive and negative voltage via the PFI and $\overline{\text{PFO}}$, as shown in Figure 16. The V_{DD} monitors the positive voltage as normal and the PFI monitors the presence of the negative supply. As the differential voltage across the R_1, R_2 divider is increased, the resistor values must be chosen such that the PFI node is $<1.25\text{V}$ when the $-V$ supply is satisfactory and the positive supply is at its maximum specified value. This allows the positive supply to fluctuate within its acceptable range without signaling a reset. Driving the $\overline{\text{MR}}$ with the inverted $\overline{\text{PFO}}$ signal as shown provides for reset generation when $-V$ is not satisfactorily present. Reset will remain asserted as long as $\overline{\text{PFO}}$ is high.

When using the C_{POR} pin, avoid stray capacitance during layout as much as possible in order to minimize its effect on the t_{POR} timing.

If using a voltage resistor divider on the PFI input to critique an external voltage and intending to use the $\overline{\text{MR}}$ input to initiate resets then avoid having the PFI voltage less than $\text{PFI } V_{\text{th}} + 2.2\text{V}$ as unintended PFO transition may occur when $\overline{\text{MR}}$ is transitioning high.



FIGURE 16. $\pm 5\text{V}$ MONITORING

Special Application Considerations

Using good decoupling practices will prevent transients (i.e., due to switching noises and short duration droops in the supply voltage) from causing unwanted resets.



FIGURE 17. ISL88705EVAL1 SCHEMATIC (TOP BANK)

Revision History

The revision history provided is for informational purposes only and is believed to be accurate, but not warranted. Please go to the web to make sure that you have the latest revision.

DATE	REVISION	CHANGE
November 30, 2015	FN8092.6	<p>Updated Ordering Information table on page 2. Added Revision History and About Intersil sections. Updated Package Outline Drawing M8.15 to the latest revision. Changes are as follows:</p> <ul style="list-style-type: none"> -Updated to new POD format by removing table and moving dimensions onto drawing and adding land pattern. -Changed in Typical Recommended Land Pattern the following: 2.41(0.095) to 2.20(0.087) 0.76 (0.030) to 0.60(0.023) 0.200 to 5.20(0.205) -Changed Note 1 "1982" to "1994".

About Intersil

Intersil Corporation is a leading provider of innovative power management and precision analog solutions. The company's products address some of the largest markets within the industrial and infrastructure, mobile computing and high-end consumer markets.

For the most updated datasheet, application notes, related documentation and related parts, please see the respective product information page found at www.intersil.com.

You may report errors or suggestions for improving this datasheet by visiting www.intersil.com/ask.

Reliability reports are also available from our website at www.intersil.com/support

© Copyright Intersil Americas LLC 2005-2015. All Rights Reserved.
 All trademarks and registered trademarks are the property of their respective owners.

For additional products, see www.intersil.com/en/products.html

Intersil products are manufactured, assembled and tested utilizing ISO9001 quality systems as noted in the quality certifications found at www.intersil.com/en/support/qualandreliability.html

Intersil products are sold by description only. Intersil may modify the circuit design and/or specifications of products at any time without notice, provided that such modification does not, in Intersil's sole judgment, affect the form, fit or function of the product. Accordingly, the reader is cautioned to verify that datasheets are current before placing orders. Information furnished by Intersil is believed to be accurate and reliable. However, no responsibility is assumed by Intersil or its subsidiaries for its use; nor for any infringements of patents or other rights of third parties which may result from its use. No license is granted by implication or otherwise under any patent or patent rights of Intersil or its subsidiaries.

For information regarding Intersil Corporation and its products, see www.intersil.com

Plastic Dual-In-Line Packages (PDIP)

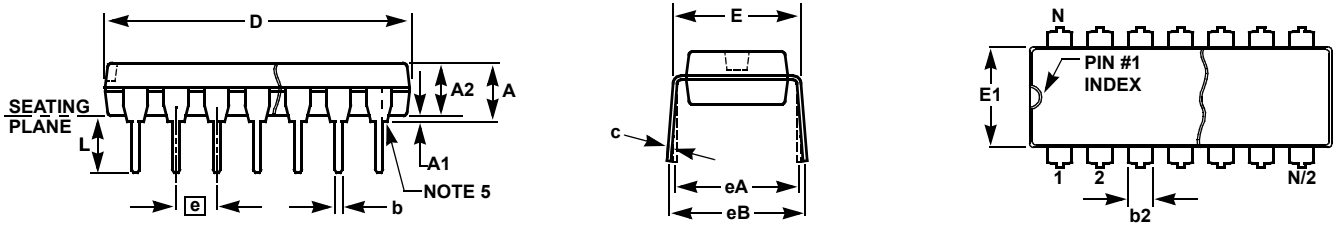

MDP0031

PLASTIC DUAL-IN-LINE PACKAGE

SYMBOL	INCHES					TOLERANCE	NOTES
	PDIP8	PDIP14	PDIP16	PDIP18	PDIP20		
A	0.210	0.210	0.210	0.210	0.210	MAX	
A1	0.015	0.015	0.015	0.015	0.015	MIN	
A2	0.130	0.130	0.130	0.130	0.130	±0.005	
b	0.018	0.018	0.018	0.018	0.018	±0.002	
b2	0.060	0.060	0.060	0.060	0.060	+0.010/-0.015	
c	0.010	0.010	0.010	0.010	0.010	+0.004/-0.002	
D	0.375	0.750	0.750	0.890	1.020	±0.010	1
E	0.310	0.310	0.310	0.310	0.310	+0.015/-0.010	
E1	0.250	0.250	0.250	0.250	0.250	±0.005	2
e	0.100	0.100	0.100	0.100	0.100	Basic	
eA	0.300	0.300	0.300	0.300	0.300	Basic	
eB	0.345	0.345	0.345	0.345	0.345	±0.025	
L	0.125	0.125	0.125	0.125	0.125	±0.010	
N	8	14	16	18	20	Reference	

Rev. C 2/07

NOTES:

1. Plastic or metal protrusions of 0.010" maximum per side are not included.
2. Plastic interlead protrusions of 0.010" maximum per side are not included.
3. Dimensions E and eA are measured with the leads constrained perpendicular to the seating plane.
4. Dimension eB is measured with the lead tips unconstrained.
5. 8 and 16 lead packages have half end-leads as shown.

Package Outline Drawing

M8.15

8 LEAD NARROW BODY SMALL OUTLINE PLASTIC PACKAGE

Rev 4, 1/12

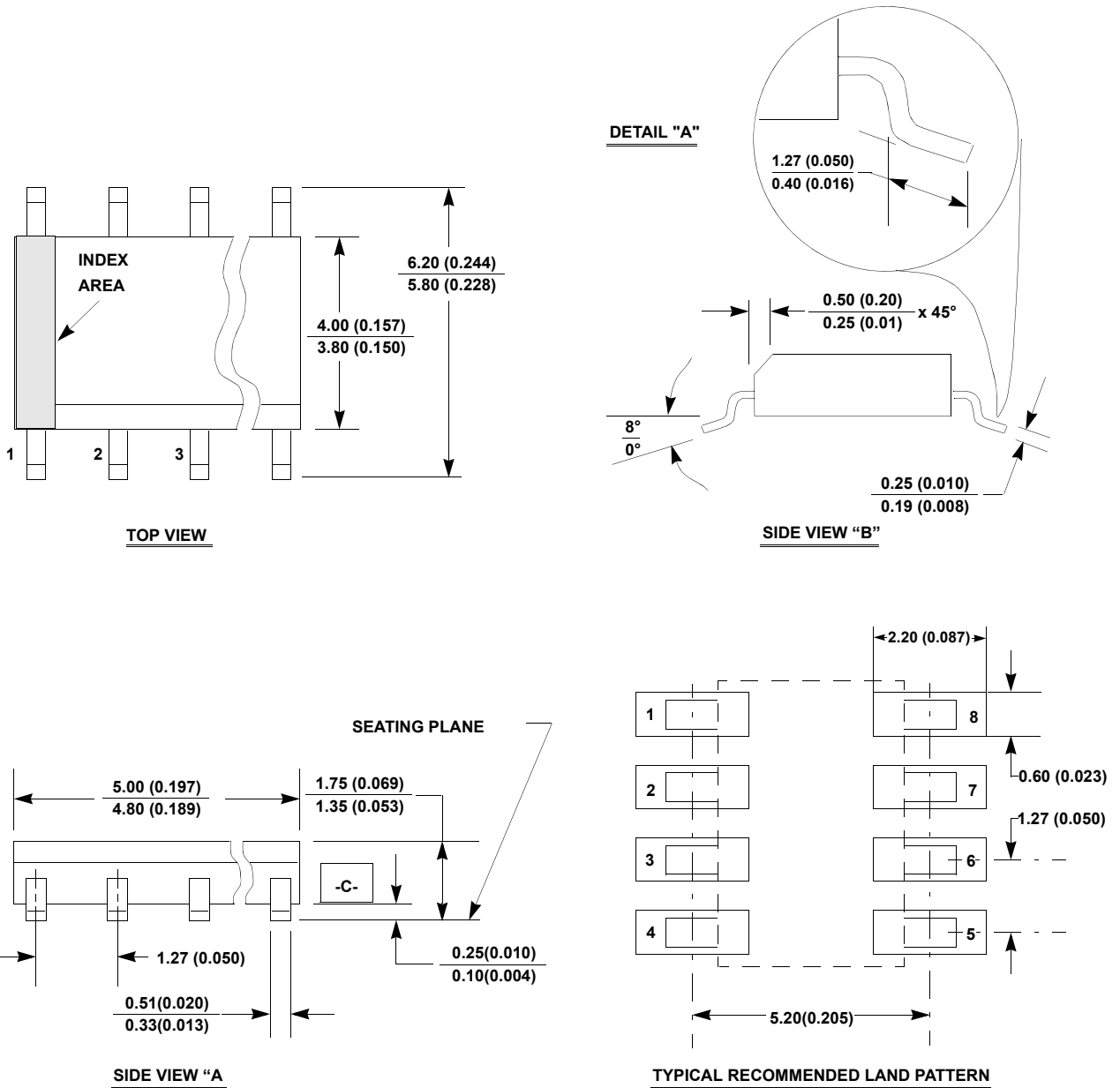

NOTES:

1. Dimensioning and tolerancing per ANSI Y14.5M-1994.
2. Package length does not include mold flash, protrusions or gate burrs. Mold flash, protrusion and gate burrs shall not exceed 0.15mm (0.006 inch) per side.
3. Package width does not include interlead flash or protrusions. Interlead flash and protrusions shall not exceed 0.25mm (0.010 inch) per side.
4. The chamfer on the body is optional. If it is not present, a visual index feature must be located within the crosshatched area.
5. Terminal numbers are shown for reference only.
6. The lead width as measured 0.36mm (0.014 inch) or greater above the seating plane, shall not exceed a maximum value of 0.61mm (0.024 inch).
7. Controlling dimension: MILLIMETER. Converted inch dimensions are not necessarily exact.
8. This outline conforms to JEDEC publication MS-012-AA ISSUE C.