

PTH05060 5 Vin

Total Power: 36 Watts
of Outputs: Single

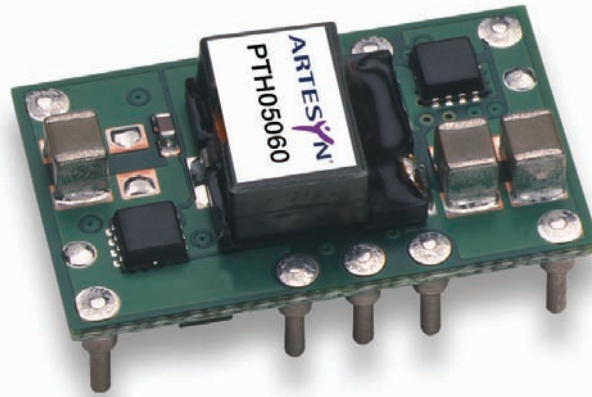

Special Features

- 10 A output current
- 5 V input voltage
- Wide-output voltage adjust 0.8 Vdc to 3.6 Vdc
- Auto-track™ sequencing*
- Margin up/down controls
- Pre-bias start-up capability
- Efficiencies up to 94%
- Output ON/OFF inhibit
- Output voltage sense
- Point-of-Load-Alliance (POLA) compatible
- Available RoHS compliant
- 2 Year Warranty

Safety

- UL/cUL CAN/CSA-C22.2 No. 60950-1-03/UL 60950-1, File No. E174104
- TÜV Product Service (EN60950) Certificate No. B 04 06 38572 044
- CB Report and Certificate to IEC60950, Certificate No. US/8292/UL

Specifications

Input		
Input voltage range:	(See Note 3, page 3)	4.5 - 5.5 Vdc
Input current:	No load	10 mA typ.
Remote ON/OFF:	(See Note 1, page 3)	Positive logic
Start-up time:		1 V/ms
Undervoltage lockout:		3.7 - 4.3 V typ.
Track input voltage:	Pin 8 (See Note 6 & 7, page 3)	± 0.3 Vin
Output		
Voltage adjustability:	(See Note 4, page 3)	0.8 - 3.6 Vdc
Setpoint accuracy:		± 2.0% Vo
Line regulation:		± 10 mV typ.
Load regulation:		± 12 mV typ.
Total regulation:		± 3.0% Vo
Minimum load:		0 A
Ripple and noise:	20 MHz bandwidth	25 mV pk-pk
Temperature co-efficient:	-40 °C to +85 °C	± 0.5% Vo
Transient response: (See Note 5, page 3)		70 μs recovery time Overshoot/undershoot 100 mV
Margin adjustment:		± 5.0% Vo

All specifications are typical at nominal input, full load at 25 °C unless otherwise stated
C_{in} = 330 μF, C_{out} = 0 μF

*Auto-track™ is a trade mark of Texas Instruments



Specifications Continued

EMC Characteristics		
Electrostatic discharge:	EN61000-4-2, IEC801-2	
Conducted immunity:	EN61000-4-6	
Radiated immunity:	EN61000-4-3	

General Specifications		
Efficiency:	See efficiency table on page 3	94% max
Insulation voltage:		Non-Isolated
Switching frequency:		300 kHz typ. ±25 kHz
Approvals and standards:		EN60950, UL/cUL60950
Material flammability:		UL94V-0
Dimensions:	(L x W x H)	25.27 x 15.75 x 9.00 mm 0.995 x 0.620 x 0.354 in
Weight:		3.7g (0.13 oz)
MTBF:	Telcordia SR-332	7,092,000 hours

Environmental Specifications

Thermal performance: (See Note 2, page 3)	Operating ambient, temperature Non-operating	-40° C to +85 °C -40° C to +125 °C
MSL ('Z' suffix only):	JEDEC J-STD-020C	Level 3

Protection		
Short circuit:	Auto reset	20 A typ.

Ordering Information

Output Power (max)	Input Voltage	Output Voltage	Output Currents		Efficiency (max)	Regulation		Model Numbers ^(9, 10)
			Min	Max		Line	Load	
36 W	4.5 - 5.5 Vdc	0.8 - 3.6 Vdc	0 A	10 A	94%	± 10 mV	± 12 mV	PTH05060

Part Number System with Options

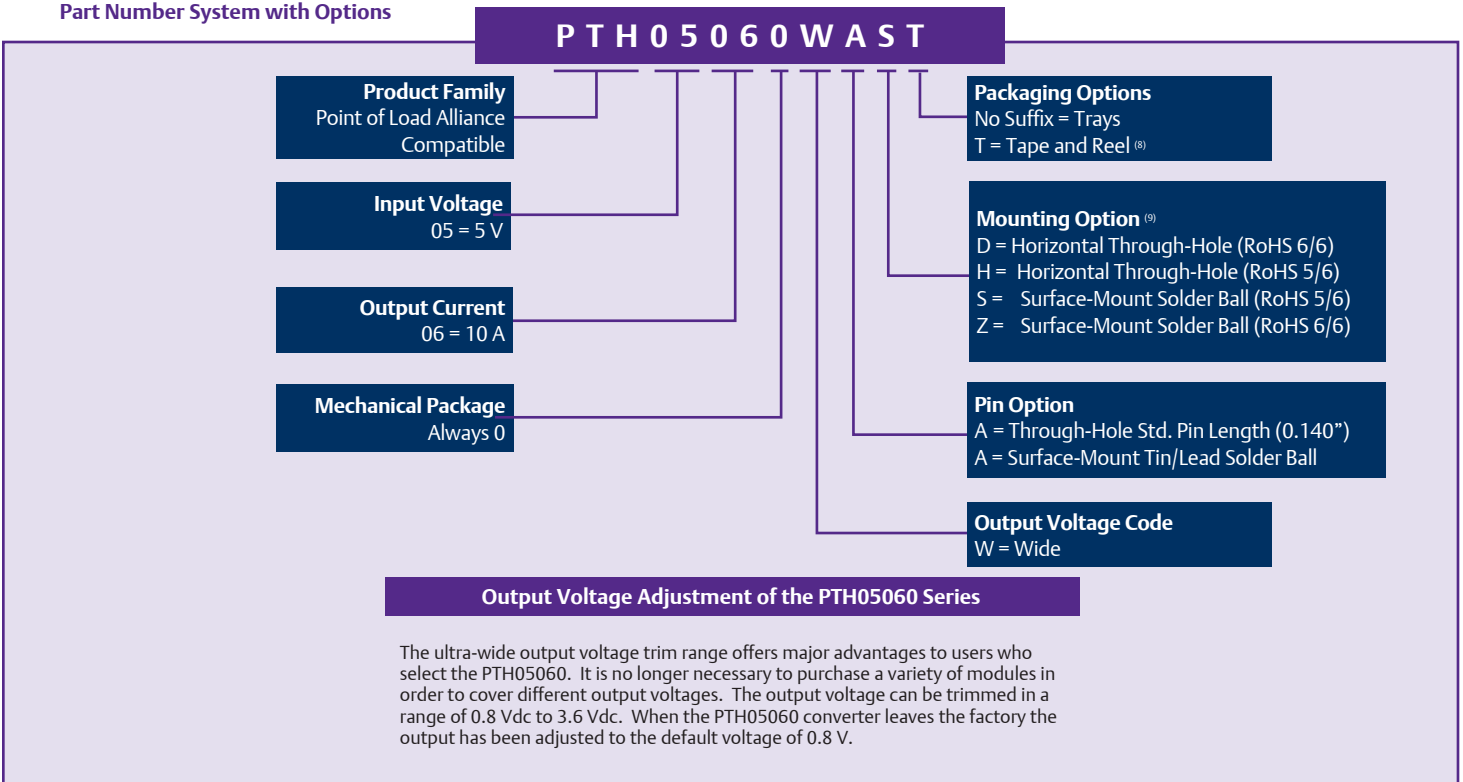

Efficiency Table ($I_O = 7\text{ A}$)

Output Voltage	Efficiency
$V_O = 1.0\text{ V}$	85%
$V_O = 1.2\text{ V}$	86%
$V_O = 1.5\text{ V}$	89%
$V_O = 1.8\text{ V}$	90%
$V_O = 2.0\text{ V}$	91%
$V_O = 2.5\text{ V}$	92%
$V_O = 3.3\text{ V}$	94%

Notes

- Remote ON/OFF. Positive Logic
ON: Pin 3 open; or $V > V_{in} - 0.5\text{ V}$
OFF: Pin 3 GND; or $V < 0.8\text{ V}$ (min - 0.2 V).
- See Figures 1 and 2 for safe operating curves.
- A 330 μF electrolytic input capacitor is required for proper operation. The capacitor must be rated for a minimum of 500 mA rms of ripple current.
- An external output capacitor is not required for basic operation. Adding 330 μF of distributed capacitance at the load will improve the transient response.
- 1 A/ μs load step, 50 to 100% I_{Omax} , $C_{out} = 330\ \mu\text{F}$.
- If utilized V_{out} will track applied voltage by $\pm 0.3\text{ V}$ (up to V_O set point).
- The pre-bias start-up feature is not compatible with Auto-Track™. This is because when the module is under Auto-Track™ control, it is fully active and will sink current if the output voltage is below that of a back-feeding source. Therefore to ensure a pre-bias hold-off, one of the following two techniques must be followed when input power is first applied to the module. The Auto-Track™ function must either be disabled, or the module's output held off using the inhibit pin. Refer to Application Note 159 for more details.
- Tape and reel packaging only available on the surface-mount versions.
- To order Pb-free (RoHS compatible) surface-mount parts replace the mounting option 'S' with 'Z', e.g. PTH05060WAZ. To order Pb-free (RoHS compatible) through-hole parts replace the mounting option 'H' with 'D', e.g. PTH05060WAD.
- NOTICE: Some models do not support all options. Please contact your local Emerson Network Power representative or use the on-line model number search tool at <http://www.PowerConversion.com> to find a suitable alternative.

Characteristic Data

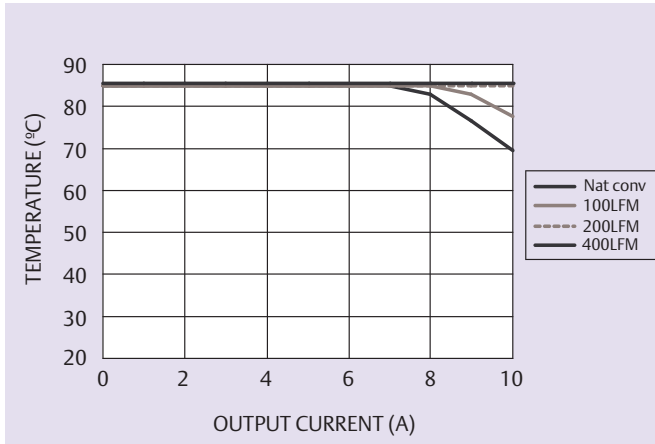

Figure 1 - Safe Operating Area
Vin = 5 V, Output Voltage = 3.3 V (See Note A)

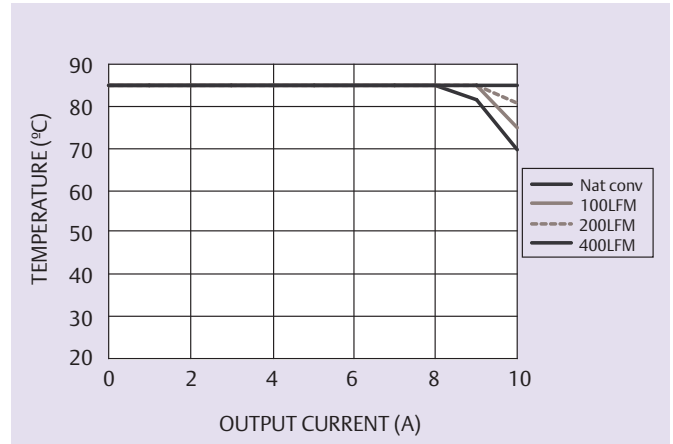

Figure 2 - Safe Operating Area
Vin = 5 V, Output Voltage = 1.0 V (See Note A)

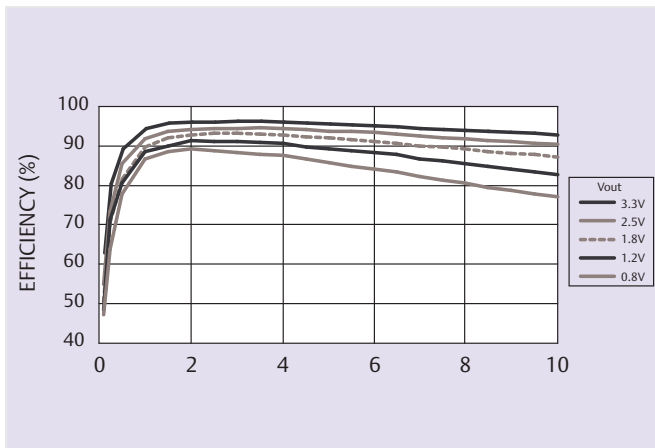

Figure 3 - Efficiency vs Load Current
Vin = 5 V (See Note B)

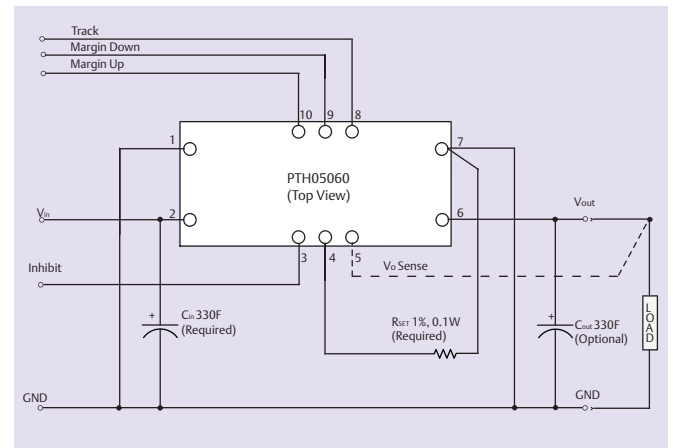

Figure 4 - Standard Application

Notes

- A SOA curves represent the conditions at which internal components are within the Emerson Network Power derating guidelines.
- B Characteristic data has been developed from actual products tested at 25 °C. This data is considered typical data for the converter.

Mechanical Drawings

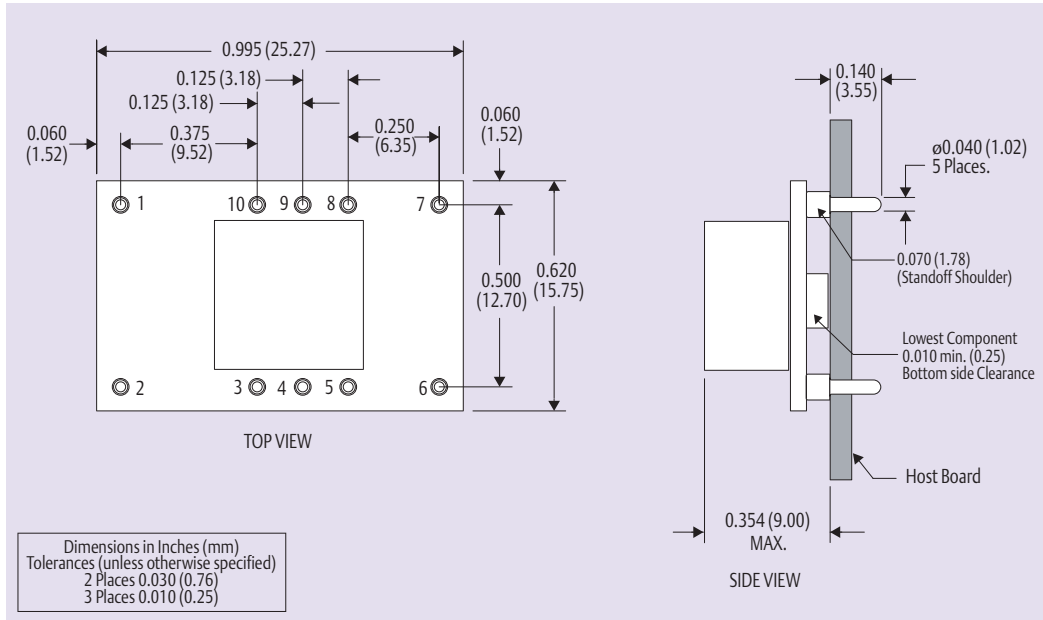

Figure 5 - Plated Through-Hole

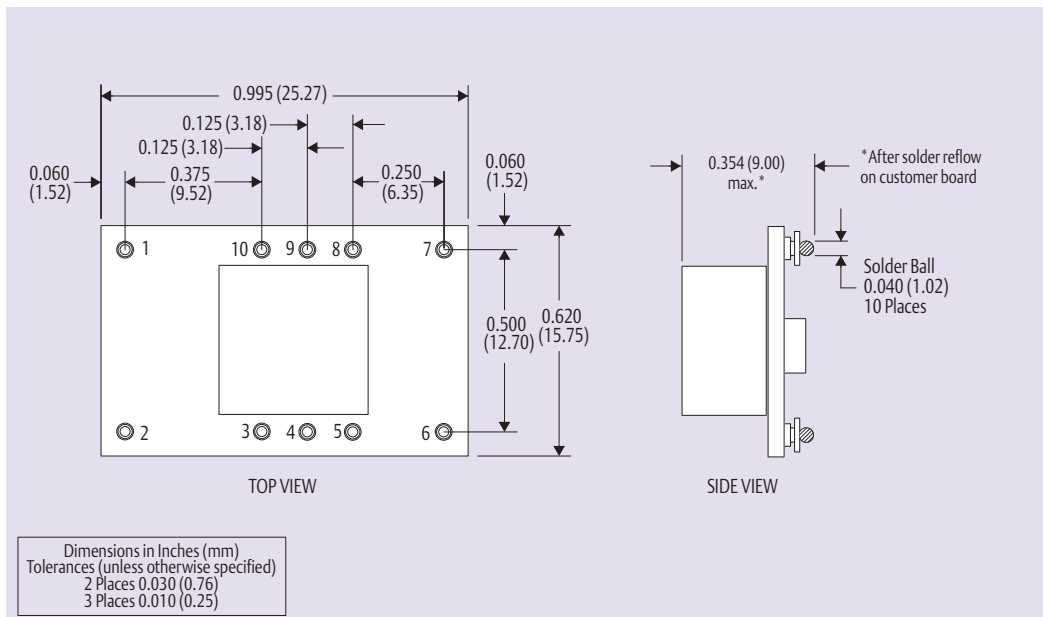

Figure 6 - Surface-Mount

Pin Connections	
Pin No.	Function
Pin 1	Ground
Pin 2	Vin
Pin 3	Inhibit*
Pin 4	Vo adjust
Pin 5	Vo sense

Pin Connections cont.	
Pin No.	Function
Pin 6	Vout
Pin 7	Ground
Pin 8	Track
Pin 9	Margin down*
Pin 10	Margin up*

* Denotes negative logic:
Open = Normal operation
Ground = Function active

Americas

5810 Van Allen Way
Carlsbad, CA 92008
USA
Telephone: +1 760 930 4600
Facsimile: +1 760 930 0698

Europe (UK)

Waterfront Business Park
Merry Hill, Dudley
West Midlands, DY5 1LX
United Kingdom
Telephone: +44 (0) 1384 842 211
Facsimile: +44 (0) 1384 843 355

Asia (HK)

14/F, Lu Plaza
2 Wing Yip Street
Kwun Tong, Kowloon
Hong Kong
Telephone: +852 2176 3333
Facsimile: +852 2176 3888

For global contact, visit:

www.PowerConversion.com
techsupport.embeddedpower@emerson.com

While every precaution has been taken to ensure accuracy and completeness in this literature, Emerson Network Power assumes no responsibility, and disclaims all liability for damages resulting from use of this information or for any errors or omissions.

Emerson Network Power.
The global leader in enabling
business-critical continuity.

- AC Power
- Connectivity
- DC Power
- Embedded Computing
- Embedded Power
- Monitoring
- Outside Plant
- Power Switching & Controls
- Precision Cooling
- Racks & Integrated Cabinets
- Services
- Surge Protection

EmersonNetworkPower.com

Emerson Network Power and the Emerson Network Power logo are trademarks and service marks of Emerson Electric Co. ©2008 Emerson Electric Co.